

97-1015C
SAND96-0430E
Submitted to the

CONF-9709108--

1997 International Workshop on
New Models and Numerical Codes for Shock Wave Processes in Condensed Media
September 15-19, 1997, Oxford, England

A SURVEY OF NUMERICAL METHODS FOR SHOCK PHYSICS APPLICATIONS

E. S. Hertel, Jr.
Sandia National Laboratories
Albuquerque, New Mexico 87185-0819

RECEIVED
OCT 10 1997
OSTI

Abstract

Hydrocodes or more accurately, shock physics analysis packages, have been widely used in the United States Department of Energy (DOE) laboratories and elsewhere around the world for over 30 years. Initial applications included weapons effects studies where the pressure levels were high enough (substantially above the yield surface of representative materials) to disregard the material strength, hence the term "hydrocode." Over the last 30 years, Sandia has worked extensively to develop and apply advanced hydrocodes to armor/anti-armor interactions, warhead design, high explosive initiation, and nuclear weapon safety issues. The needs of the DOE have changed over the last 30 years, especially over the last decade. A much stronger emphasis is currently placed on the details of material deformation and high explosive initiation phenomena. The hydrocodes of 30 years ago have now evolved into sophisticated analysis tools that can replace testing in some situations and complement it in all situations.

A brief history of the development of hydrocodes in the United States will be given. I will also discuss and compare the four principal methods in use today for the solution of the conservation equations of mass, momentum, and energy for shock physics applications. The techniques discussed are the Eulerian methods currently employed by the Sandia multi-dimensional shock physics analysis package known as CTH; the element based Lagrangian method currently used by codes like DYNA; the element free Lagrangian method (also known as smooth particle hydrodynamics) used by codes like the Los Alamos code SPHINX; and the Arbitrary Lagrangian Eulerian methods used by codes like the Lawrence Livermore code CALE or the Sandia code ALEGRA.

Acknowledgments

This work was performed at Sandia National Laboratories as supported by the U. S. Department of Energy under contract DE-AC04-94AL85000. The author also acknowledges the assistance of three individuals, Leonard Wilson of the Navy Surface Warfare Center, Dahlgren Division, Dan Carroll and Tim Trucano both of Sandia National Laboratories. Their contributions in running some of the simulations that will be discussed here were appreciated.

Introduction

Numerical simulations can offer a significant complement to experimental methods for studying dynamic material behavior. For example, simulations allow non-intrusive investigation of material response at interior points of a sample. No gauges, wires or other instrumentation are required to extract the information on the state of the material. The response at any of the discrete points in a numerical simulation can be monitored throughout the calculation simply by recording the material state at each time step of the calculation. Arbitrarily fine resolution in space and time is possi-

dy
DISTRIBUTION OF THIS DOCUMENT IS UNLIMITED

MASTER

DISCLAIMER

This report was prepared as an account of work sponsored by an agency of the United States Government. Neither the United States Government nor any agency thereof, nor any of their employees, makes any warranty, express or implied, or assumes any legal liability or responsibility for the accuracy, completeness, or usefulness of any information, apparatus, product, or process disclosed, or represents that its use would not infringe privately owned rights. Reference herein to any specific commercial product, process, or service by trade name, trademark, manufacturer, or otherwise does not necessarily constitute or imply its endorsement, recommendation, or favoring by the United States Government or any agency thereof. The views and opinions of authors expressed herein do not necessarily state or reflect those of the United States Government or any agency thereof.

DISCLAIMER

**Portions of this document may be illegible
in electronic image products. Images are
produced from the best available original
document.**

ble, limited only by the availability of computer memory and time.

If we can assume valid material models, numerical simulations can explore material response in pressure and temperature regimes that are beyond available experimental or diagnostic capabilities to investigate. Hypervelocity impacts can be studied in velocity regimes that exceed present projectile launcher capabilities, and detailed investigation of material response can be made where temperatures would preclude use of diagnostic apparatus in any experimental study, e.g., in materials subjected to intense x-ray energy deposition or in expanding products of chemical explosives, etc.

Furthermore, in many cases, numerical studies can be done in less time and at lower cost than experimental studies. In general, small changes in problem parameters, such as material thicknesses, impact conditions, or material properties, merely involve changes to the problem input file. These changes in a numerical study can often be made in a matter of minutes; whereas, corresponding changes in an experimental configuration may require additional machining and assembly of hardware and can, therefore, be quite time-consuming.

Simulations are only useful, however, insofar as there is some reason to have confidence in the accuracy of the solution method and material response models used in the calculations. Presently, accurate material response models exist for only a small part of the spectrum of materials and loading regimes of interest in shock compression studies. One notable shortcoming of present modeling techniques is the lack of capability to predict failure and post-failure response for most materials of practical interest. Also, the response of many materials is strongly influenced by micro-mechanical factors which cannot be modeled explicitly and are not sufficiently well-understood to be incorporated in macroscopic models. Composites, which are of great and increasing importance in engineering applications, are an example of a class of materials where fidelity is lacking in numerical simulations of dynamic response in shock compression processes.

Numerical simulations are designed to solve, for the material body in question, the system of equations expressing the fundamental laws of physics to which the dynamic response of the body must conform. The detail provided by such "first-principles" solutions can often be used to develop simplified methods for predicting the outcome of physical processes. These simplified analytic techniques have the virtue of numerical efficiency and are, therefore, preferable to numerical simulations for parameter sensitivity studies. Typically, rather restrictive assumptions are made on the bounds of material response in order to simplify the problem and make it tractable to analytic methods of solution. Thus, analytic methods lack the generality of numerical simulations and care must be taken to apply them only to problems where the assumptions on which they are based will be valid. This can apply also to hydrocodes, particularly with respect to material models and their validity.

The problems solved by large deformation hydrocodes are quite challenging for several reasons. The geometry can be very complex, such as would be the case in modeling bridges, space vehicles, or missiles. The phenomena can be highly nonlinear, including for example nonlinear material models, fracture, or buckling. The codes must be minimally capable of resolving gross behavior of the discontinuous fields without undue expense. The material models may be very complex, encompassing strain history dependent plasticity, internal voids, or anisotropic response. Tremendous progress has been made over the last forty years, but much remains to be done.

Overview and Historical Perspective

Hydrocodes in the United States generally fall into two categories, loosely referred to as Lagrangian and Eulerian. Lagrangian codes solve the conservation equations in the material frame, the computational mesh therefore deforming with the material as a function of time. Eulerian codes solve the conservation equations in the spatial frame, so that the computational mesh is fixed space as the deformation of the material occurs as a function of time. The solution technique used for contemporary Lagrangian codes is generally a finite element method and the solution technique for Eulerian codes is generally a finite difference method. Gridless techniques, such as smooth particle hydrodynamics (SPH) are Lagrangian in nature. Hybrid methods are also possible using features of both Lagrangian and Eulerian codes and are commonly referred to as Arbitrary Lagrangian Eulerian (ALE) methods.

All hydrocodes in current use today solve the conservation equations (mass, momentum, and energy) using either Lagrangian or Eulerian techniques and explicit time stepping. All methods in current use have quirks and pluses and minuses depending on the specific code. Several general comments can be made for the major classes of codes. Because Eulerian techniques solve the conservation equations on a mesh fixed in space, the material moves through the computational mesh. The conservation equations are solved with either finite difference or finite volume numerical techniques. The Eulerian techniques have several pluses; they have a simple mechanism for creating free surface in fracture and fragmentation, they are computationally robust for large deformation material mechanics, and they have a very simple scheme for mesh development and material insertion. They also have several minuses; they can be computationally intensive in cpu and memory requirements, they have problems with surface recognition (i.e., material interfaces), and poor numerical techniques can lead to excessive shock diffusion. An example of the effects of solution accuracy on diffusion can be seen in Figure 1. An inspection of the solution in Figure 1 quickly shows the improved result with a second order difference scheme. Both results were obtained using CTH, the production second order scheme being replaced with a first order difference equation as an illustration. Even though we refer to CTH as a second order code, many operations are performed during the solution sequence that cannot be proven to be second order. This lack of mathematical proof of accuracy is a major difference between finite difference and finite element based solution techniques. The first order results could be improved by adding resolution, but at the cost of added memory and cpu requirements. However, there are phenomena (contact discontinuities and mach stems) that can never be resolved with first order techniques.

Lagrangian techniques solve the conservation equations on a mesh which moves with the material. The conservation equations are generally solved using finite difference or finite element techniques, with finite element techniques becoming increasingly popular. More novel approaches include Free Lagrangian and SPH. Straightforward Lagrangian techniques have several pluses; they can be computationally less intensive in cpu and memory requirements and they can accurately recognize material interfaces or surfaces. They also have several minuses; free surface creation in fracture and fragmentation is difficult and relies on ad hoc algorithms, large deformation frequently leads to mesh tangling or inversion, mesh development can be extremely difficult in three-dimensions and may be the limiting factor in very large scale computing, and contact surface algorithms can be difficult to implement in even in two-dimensions and certainly in three-dimensions. The difficulties noted here are the driving factor behind the development of meshless techniques such as SPH.

Figure 1: Solution Accuracy Example

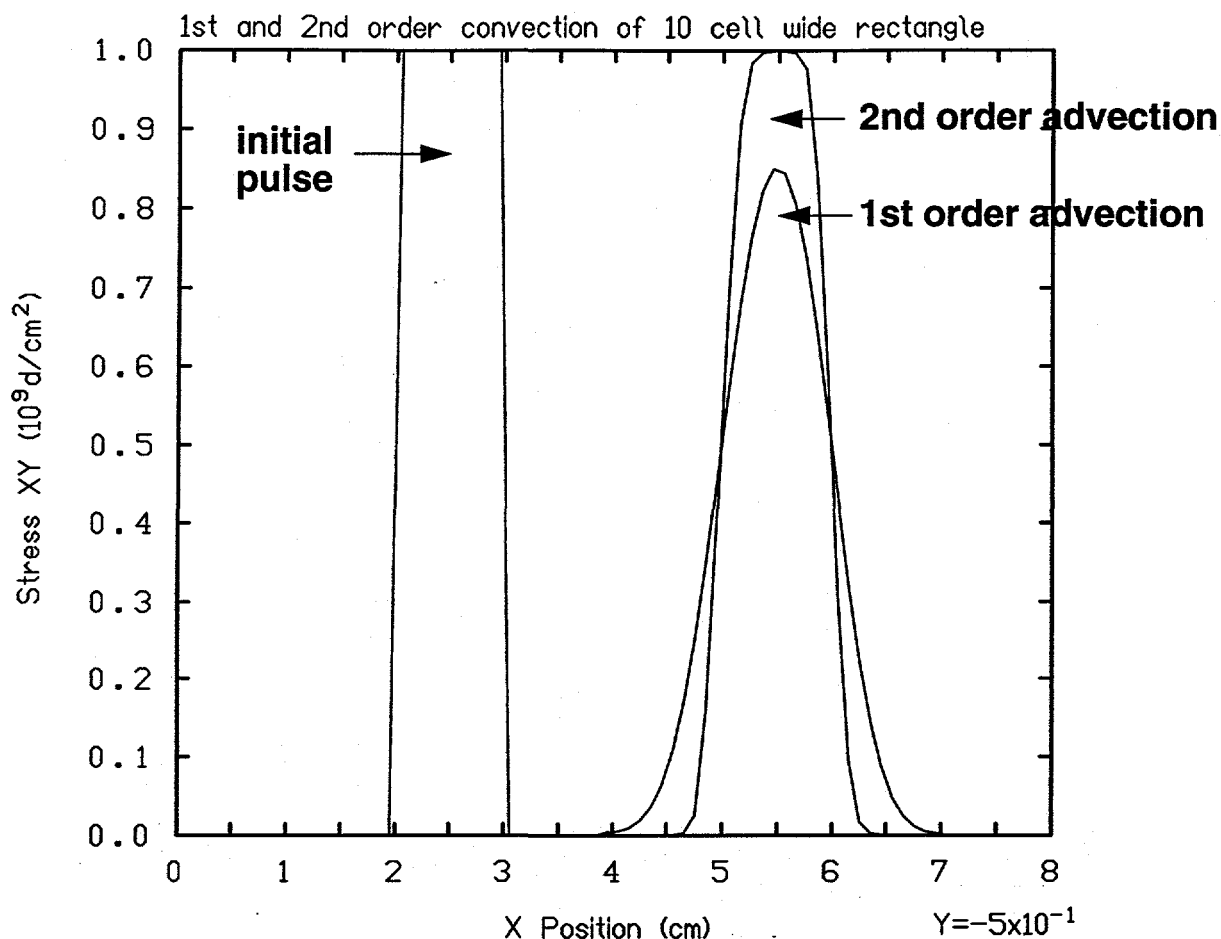

Many hydrocodes have been written and used over the last 50 years but only a few of those codes have gained a reputation and/or widespread use. I will focus on those codes in the later category. Shock physics calculations date back to the mid 1940's. The original calculations were Lagrangian and done primarily by hand and were used to develop loading and timing conditions in high explosive implosion systems for the Manhattan project. The first published Eulerian method was a technique known as particle-in-cell (PIC) was developed at Los Alamos by Evans and Harlow (1957). The PIC technique is Eulerian in nature as it relies on a mesh fixed in space. The 1960's and early 1970's was the time of rapid development in computational shock physics. Wilkins of Lawrence Livermore and Herrmann of MIT (and later Sandia) developed the first one-dimensional Lagrangian codes. The first method of characteristics codes were developed in the same time frame, principally by Lynn Barker of Sandia. During the same time Johnson and coworkers were developing the first general purpose modern Eulerian codes. These initial codes were one-dimensional in nature but were rapidly generalized to two-dimensions. Figure 2 shows a "family tree" of the major Eulerian codes of the last 40 years. The essence of the US Eulerian code development effort was due to the work of a small number of individuals: Walsh, Johnson, and Hageman; Durrett and Matuska; and Thompson and McGlaun. The current state of the art for non-nuclear Eulerian techniques is embodied in the codes from Los Alamos, Lawrence Liver-

Figure 2: Eulerian Code Family Tree

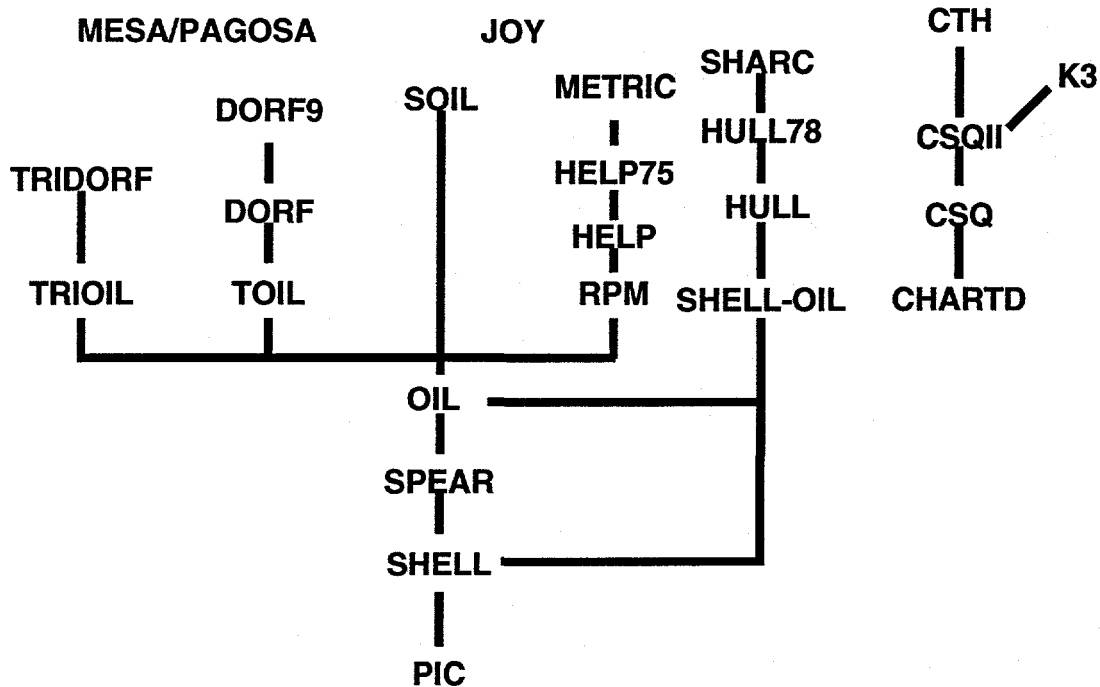

more, and Sandia National Laboratories; JOY, MESA, and CTH. The codes are similar in architecture and capabilities although CTH is the only one of the three that has continued to evolve, especially with respect to computer hardware requirements. As an example of the state of the art of Eulerian codes, a short description of CTH is given in a later section.

The work of Wilkins and Herrmann was continued in much the same way as in the Eulerian community. Figure 3 shows a "family tree" of some major Lagrangian codes of the last 40 years. The essence of the US Lagrangian code development efforts was also due to the efforts of a small number of individuals: Wilkins and Halquist; G. Johnson; and Herrmann, Swegle, and Kipp. The current state of the art for Lagrangian techniques is embodied in the codes from Lawrence Livermore and Sandia National Laboratories, and Alliant TechSystems; DYNA, PRONTO, and EPIC. The codes selected for inclusion in Figure 3 are similar in architecture in that the more recent of them rely on a finite element formulation to solve the conservation equations, but differ significantly in their capabilities and features. These differences relate to an area that I call code heuristics, that is, those features of numerical tools that do not have governing equations to justify the choices in solution techniques. An example of this idea for multi-material Eulerian codes is mixed cell thermodynamics. In a mixed cell, should the code equilibrate the energy (temperature) and pressure or should it allow each material in a mixed cell to have individual energies and pressures? For Lagrangian codes, contact surfaces, erosion and element death algorithms all fall into this category. Other differences in the major Lagrangian codes have to do with options in element types and material models. DYNA is known for a very large selection of both, whereas EPIC relies on one element type.

Figure 3: Lagrangian Code Family Tree

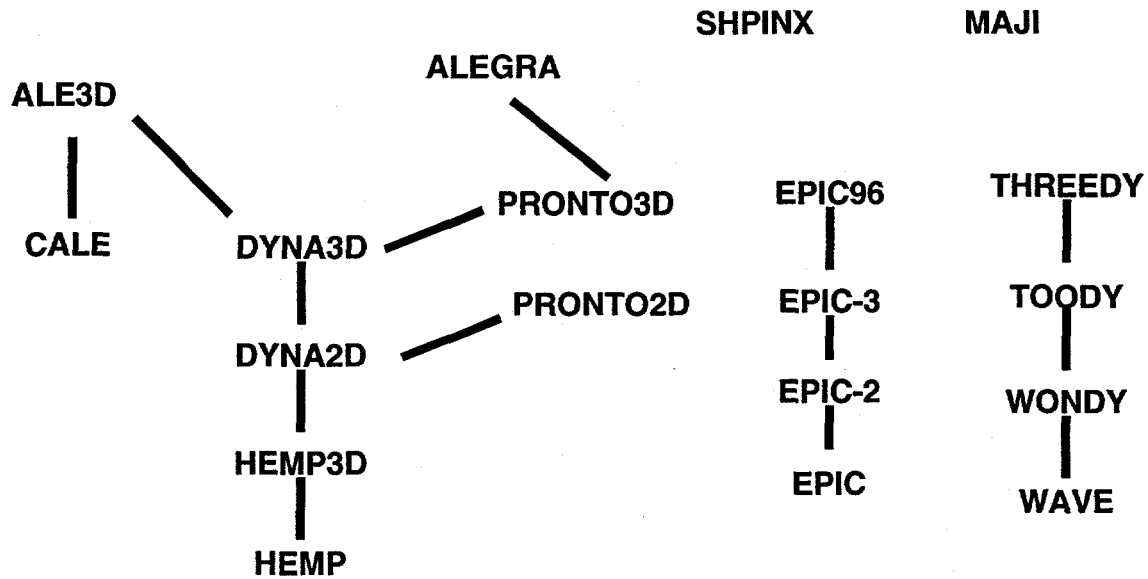

Two other classes of codes also exist in the Lagrangian arena, element free or meshless methods and mixed methods. The mixed methods are generally referred to as Arbitrary Lagrangian Eulerian (ALE) codes and the most popular meshless technique is smooth particle hydrodynamics (SPH). ALE techniques generally solve the conservation equations on an unstructured mesh with arbitrary movement prescription. This formulation allows the user to designate whether material should flow through a stationary mesh (pure Eulerian), whether the mesh should move with the material (pure Lagrangian), or whether the mesh should move independently from the material motion (arbitrary). This latter capability permits a calculation to proceed in Lagrangian fashion until the mesh becomes too highly distorted. At that time, mesh points in the most deformed portion of the mesh can be moved to reduce the distortion to acceptable levels. The advantage is that numerical dissipation associated with remapping is avoided until large deformations occur and then is limited to only those regions where there are severe mesh distortions and the mesh must be moved. ALE formulations found in CALE, ALE3D, and ALEGRA are finite element based. A complete description of the details of the numerical treatment may be found in the paper by Benson (1992).

The other class of Lagrangian solution technique is the particle or meshless method. These methods are characterized by solution variables that are attributed to (Lagrangian) point masses instead of computational cells. There are several variations but all of these techniques rely on the particles to carry the physical information such as mass, momentum, and energy. The principal beauty of these methods is the complete removal of mesh tangling as a potential numerical failure mechanism! Shock resolution and tensile instabilities are known problems with the methods. An example of shock resolution will be given in a later section. Recent work by Fahrenthold (1996) uses a novel approach to particle based hydrodynamics. This technique is based on the application of Hamilton's equations to a system of deforming physical particles. There is currently a great deal

of academic effort in general "gridless" methods, including SPH generalizations and element free Galerkin methods.

Coupling of the techniques described above is also possible. In particular, the penetration of a rigid rod into deforming material is very difficult to model with any of the individual techniques described above. In this case, the best solution technique is to treat the rod as a Lagrangian body and the target as an Eulerian body. A direct coupling of Lagrangian and Eulerian (or SPH) codes is necessary to simulate this phenomena most accurately. The Lagrangian codes EPIC and PRONTO both have SPH modules as imbedded options and have been used to simulate deep rigid penetration. In addition, CTH and either EPIC or PRONTO have been coupled in a timestep-by-timestep fashion to solve the same class of problems.

It is also important to point out that all Eulerian codes actually solve the Lagrangian form of the conservation equations as a part of the overall solution sequence. The Lagrangian step is followed by a remap step that returns the physical variables to the original mesh.

Governing Equations

The conservations equations relate material density (ρ), velocity (v_i), specific total energy (e), stress tensor (σ_{ij}), and external body forces per unit mass (f_i), where the standard tensorial notation applies. For the two solution techniques discussed in this paper, the equations are given below.

Eulerian

Conservation of Mass

$$\frac{\partial \rho}{\partial t} + \frac{\partial}{\partial x_i}(\rho v_i) = 0$$

Conservation of Momentum

$$\frac{\partial v_i}{\partial t} + v_j \frac{\partial v_i}{\partial x_j} = f_i + \frac{1}{\rho} \frac{\partial \sigma_{ji}}{\partial x_j}$$

Conservation of Energy

$$\frac{\partial E}{\partial t} + v_i \frac{\partial E}{\partial x_i} = \frac{P}{\rho^2} \left(\frac{\partial \rho}{\partial t} + v_i \frac{\partial \rho}{\partial x_i} \right) + \frac{1}{\rho} s_{ij} \dot{\epsilon}_{ij}$$

Lagrangian

Conservation of Mass

$$\frac{D\rho}{Dt} + \rho \frac{\partial v_i}{\partial x_i} = 0$$

Conservation of Momentum

$$\frac{Dv_i}{Dt} = f_i + \frac{1}{\rho} \frac{\partial \sigma_{ij}}{\partial x_j}$$

Conservation of Energy

$$\frac{DE}{Dt} = \frac{P}{\rho^2} \frac{D\rho}{Dt} + \frac{1}{\rho} s_{ij} \dot{\epsilon}_{ij}$$

Both sets of equations use the definition of the specific internal energy $e = \frac{1}{2} v_i v_i + E$ and the total

time derivative is defined as $\frac{D}{Dt} = \frac{\partial}{\partial t} + v_i \frac{\partial}{\partial x_i}$. Two more equations are required to close these

system for solution, an equation of state $P=f(\rho,E)$ and constitutive model $\sigma_{ij} = f(\epsilon_{ij}, \dot{\epsilon}_{ij}, E, D)$. The

equation of state accounts for changes in density and irreversible thermodynamics processes. The constitutive model relates the stress a material experiences to the strain (ϵ), strain rate ($\dot{\epsilon}$), internal energy (E), and damage (D).

It is the numerical solution of the above equations that forms the core content of all hydrocodes. Finite difference techniques are generally associated with the Eulerian formulation of the conservation equations but are not uniquely restricted to that formulation. Most of the early Lagrangian codes, such as the HEMP and WONDY families used the finite difference technique to solve the conservation equations. Finite element techniques are more recently associated with the Lagrangian formulation of the conservation equations.

The conservation equations describe a continuum but the computer is finite. The equations must be discretized and it is this process that uses finite difference or element techniques. Both Lagrangian and Eulerian codes use explicit formulations to advance the conservation equations in time. This can be explained as follows, the conservation equations are of the form:

$$\frac{\partial U}{\partial t} = -\frac{\partial}{\partial x} F(U) \equiv G(U).$$

Upon application of the Mean Value Theorem the new solution is given by:

$$U^{l+1} = U^l + \Delta t(\epsilon G^{l+1} + (1-\epsilon)G^l).$$

When ϵ is equal to zero, the new variables at time $(l+1)$ are given by known functions of the previous time (l) variables. Since hydrocodes are most interested in resolving shock structures, the use of an explicit time step scheme is appropriate. To resolve the shock structures very small timesteps must be taken, whether an explicit or implicit scheme is used. Typically the timesteps needed to resolve the shock are on the order of the Courant stability condition, so why place the added burden of iterations or inversion operations on the hydrocode to use an implicit scheme. When structural response (a much slower process) is of interest, the use of implicit techniques is more common.

All contemporary Eulerian codes use some form of second order advection. Furthermore, the contemporary codes use a form developed by Richtmyer and Morton (1967) that features a two-step process with two different space and time meshes. The state variables (pressure, stress, mass, volume) are space and time centered but the velocities are located at space and time half-steps. This technique leads to a scheme that is second order accurate in space and time. An added feature of this method is that the difference equations are conservative and mass, momentum, and internal energy are exactly conserved if infinite precision arithmetic are assumed. In reality, truncation and round-off errors cause the difference equations to be non-conservative.

Gordon Johnson (developer of EPIC) has described the differences between Eulerian and Lagrangian techniques as follows: "finite difference techniques are an approximate solution to an exact problem and finite element techniques are an exact solution to an approximate problem." Finite element techniques view the problem domain as composed of many small sub-regions or elements. A piece-wise approximation of the differential equations is made using an interpolation function such as a polynomial or spline. On the interpolation function the differential equations can be solved exactly. Finite element technology has been subjected to substantial mathematical rigor, Belytschko (1976) has shown that the discrete forms of the equations of motion in finite difference form are equivalent to the finite element representation in many cases.

The key differences between finite element and finite difference techniques are in the implementation details of the individual codes. The quality of the analyst may be more important than the quality or type of the solution technique.

Validation Calculations

The most important part of the code development process is the validation of the code. By validation, I am referring to the process of "proving" that a code gives accurate and robust solutions to physically realistic shock wave physics problems. Two common components in performing this task are to compare code solutions with either analytic solutions or carefully conducted experiments. I have chosen two problems for an informal comparison of code accuracy to illustrate my meaning of validation. One problem has an exact analytic solution and one problem is a comparison to experimental data. The two problems exercise different aspects of hydrocodes. The codes used for this effort were CTH, SPHINX, and ALEGRA. The solutions were obtained by various individuals, some being very familiar with the code and some not. The results for these comparison are described below.

Shock Tube

The first simulation discussed here is the classic shock tube (sometimes called Sod) problem (1978). This problem consists of a one-dimensional shock tube in which a higher density and pressure ideal gas is allowed to expand into a lower pressure and density ideal gas. For this simulation, the initial conditions are shown in Figure 4. This problem is a classical Riemann problem

Figure 4: Sod Problem Initial Conditions and CTH Solution for Two Resolutions

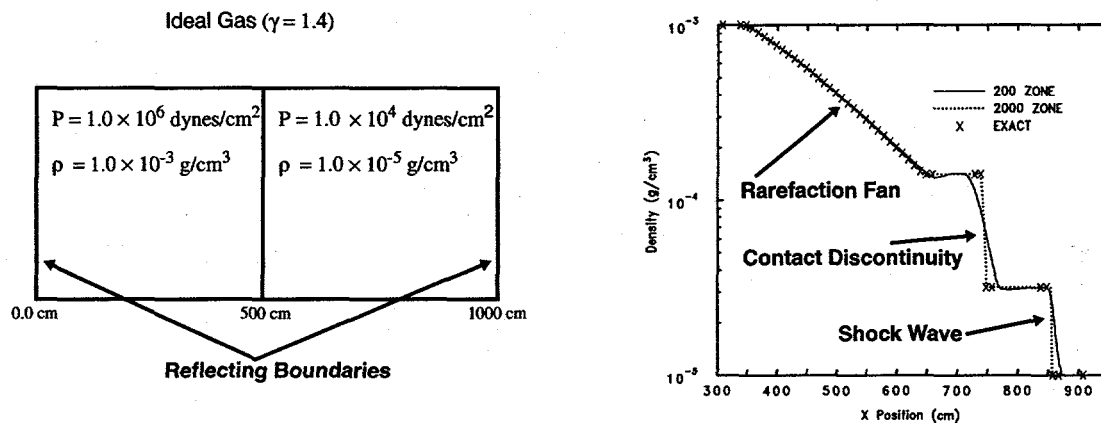

where an exact solution can be derived as long as the generated waves do not interact with the boundaries. In addition, it is a standard test problem for shock physics models because three typical wave structures—a rarefaction fan, a contact discontinuity, and a shock wave occur in the simulation. Figure 4 also displays the density field for 200 and 2000 zone CTH simulations as compared to the exact solution. Both CTH simulations are accurate representations of the exact solutions, although the 2000 zone simulation is obviously more accurate. The 200 zone simulation is of practical interest since that represents a typical directional mesh size for two-dimensional simulations and is near the upper limit for three-dimensional domains. Both the contact

discontinuity and the shock are slightly smeared by the diffusion in the advection scheme and the artificial viscosity, respectively. Both of these effects are substantially reduced in the higher resolution simulation.

Figure 5 displays a comparison of CTH and SPH (SPHINX) results for the similar initial conditions (larger pressure and density gradients were used to further stress each code). CTH used 1000 zones to span the space and SPHINX used 1000 equal smoothing length interpolation points. The SPHINX setup did not include mass matching across the discontinuity which could have improved the results. The smoothing length is generally considered to be a rough measure of the resolution of an SPH code. ALEGRA was also run against the same initial conditions in both

Figure 5: CTH and SPHINX Solutions for the Sod Problem

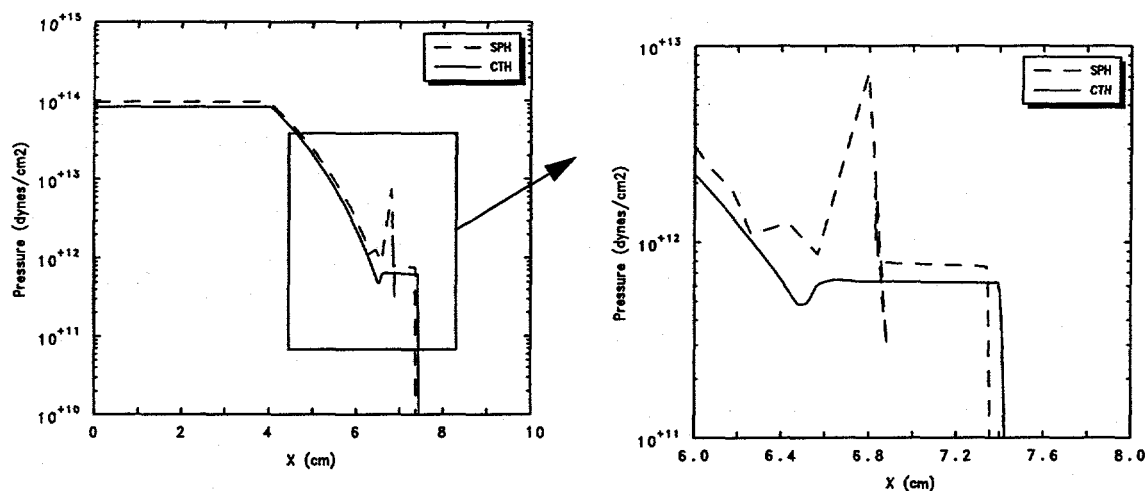

Eulerian and Lagrangian mode. The ALEGRA/Eulerian results were nearly identical to those of CTH and the ALEGRA/Lagrangian results were intermediate in accuracy to those of CTH and SPHINX. Similar simulations have been done with the finite difference Lagrangian code WONDY. This code has algorithms specifically designed for shock matching and past experience has shown extremely accurate representations of features similar to those in Figure 4. The slight vertical offset between the CTH results and SPHINX results is due to differences in the way each code parameterizes the equations of state, not to underlying errors in either method. The overshoot seen in the SPH results is disturbing and has been noted by other authors, particularly Benson (1992). Mass matching of the interface particles and other special remedies may reduce this phenomena.

Explosively Formed Projectile

As a second example I consider a more complex problem, The simulation of Explosively Formed Projectiles (EFP) is of general interest because of the range of dynamics covered in such calculations. High explosive detonation, material strength and failure, and thermodynamic extremes (hot and cold materials in contact) make this class of simulations especially useful for testing purposes. The computational representation of the EFP is shown in Figure 6. The EFP consisted of a 360 gm OFHC copper liner and approximately 1000 gm of LX-14 high explosive encased in a 1600 gm AISI 4340 steel case. The initial inner diameter of the EFP was approximately 11.7 cm, and the center-line distance between the inner surface of the steel case and

Figure 6: EFP Initial Configuration

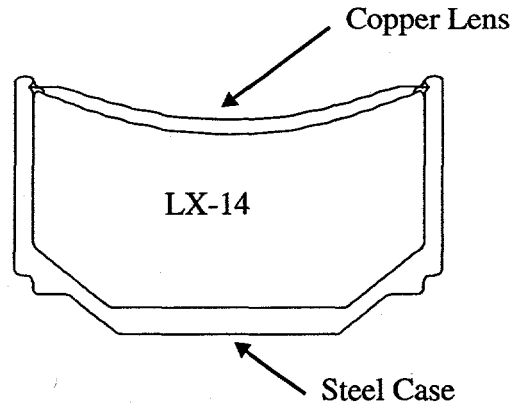

the copper-lens was slightly less than 6.0 cm. The high explosive was detonated at the center of the inner surface on the bottom of the case.

The EFP simulation was calculated to 200 μ s. At this time the EFP was fully formed. This time corresponds approximately to the time of the experimental shadowgraph. Table 1 shows the CTH results and the deviations from the experimental values for terminal velocity, length, diameter, and the length-to-diameter ratio.

Table 1. EFP Experimental Data and CTH Results

	Terminal Velocity (km/s)	Length (cm)	Diameter (cm)	Length/Diameter
Experiment	2.28	5.46	4.95	1.10
CTH	2.35	5.45	4.90	1.11
Error (%)	3.07	-0.2	-1.0	1.0

Figure 7 shows the CTH simulated shape at 200 μ s and the experimental shadowgraph. Figure 8 displays the similar result from the SPH calculation. The SPH simulation seems to suffer from excess fracture in the body of the projectile. Attempting the same simulation with ALEGRA gives rise to the solutions seen in Figures 9 through 11. Figure 9 displays a comparison of two 2D simulations showing the differences between a full Lagrangian mesh/solution and a single material ALE (SMALE) mesh/solution. Both ALEGRA simulations allow for the addition of computational void in computational cells, so in some senses, the cells are actually multi-material. Figure 10 displays a 3D ALEGRA simulation, the left side of the figure gives the mesh and cells that contain any copper liner material, the right side gives the mesh and does not show the cells that contain less than 50% copper. Figure 11 displays the same 3D ALEGRA simulation in perspective view. Even though the ALEGRA calculations were run to a shorter time length, both 2D and 3D show good agreement with CTH at similar times. Difficulties with the parallel contact surface algorithm implement in ALEGRA prevented the simulations from being run to 200 μ s. ALEGRA could have been run in Eulerian mode for this comparison, but it was my desire to test the ALE features.

Figure 7: EFP Terminal Shape and Experimental Shadowgraph

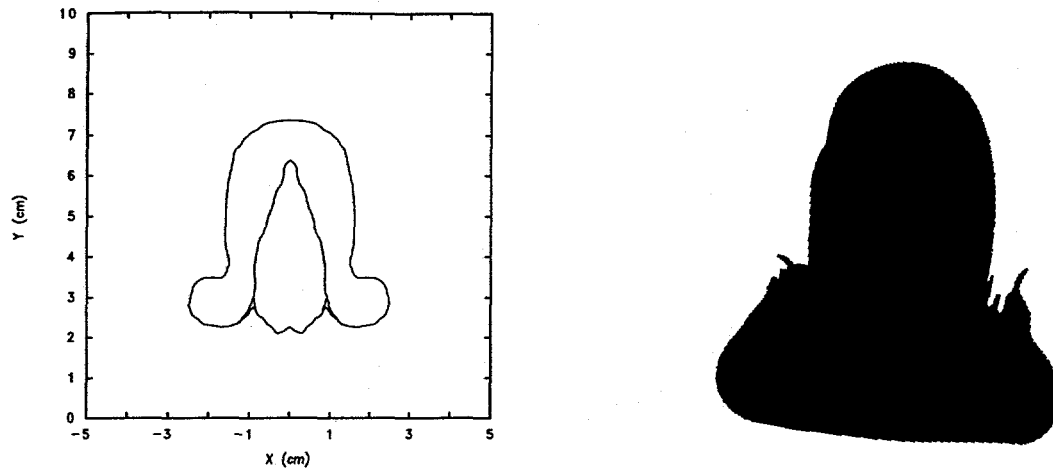
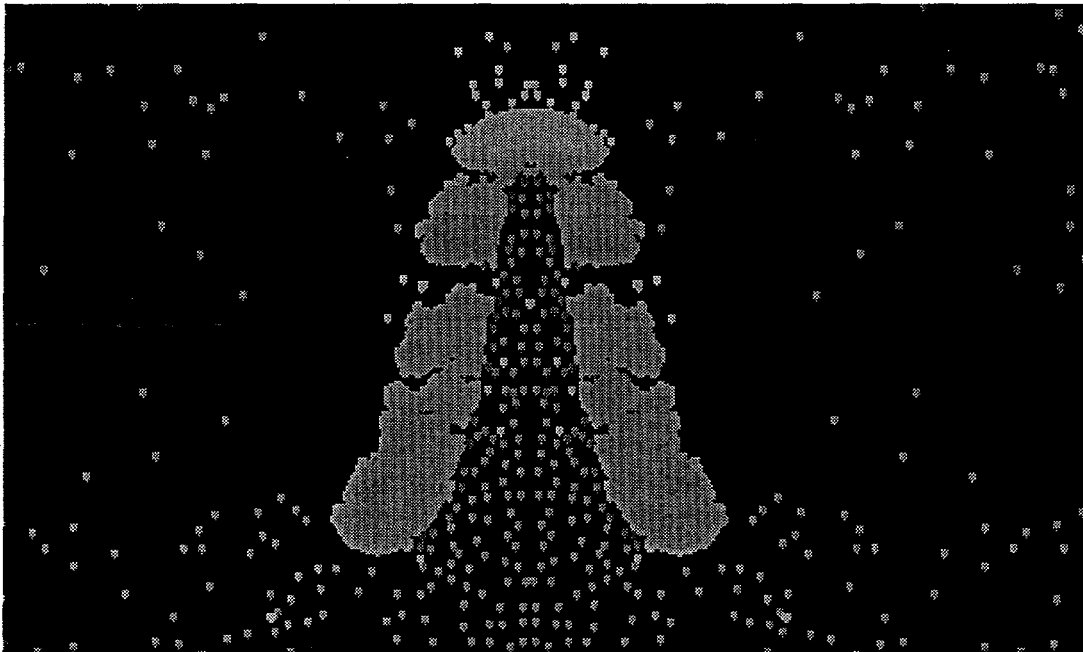

Figure 8: SPH EFP Simulation



CTH Overview

For a more detailed discussion of a general purpose Eulerian code, I am including the following overview of Sandia's Eulerian code, CTH. The CTH software family is a complete package for the initialization, integration through time, and visualization of complex phenomena surrounding shock physics. The classes of problems that can be analyzed with CTH include penetration and perforation, compression, high explosive detonation and initiation phenomena, and hypervelocity impact.

Figure 9: ALEGRA 2D Simulations

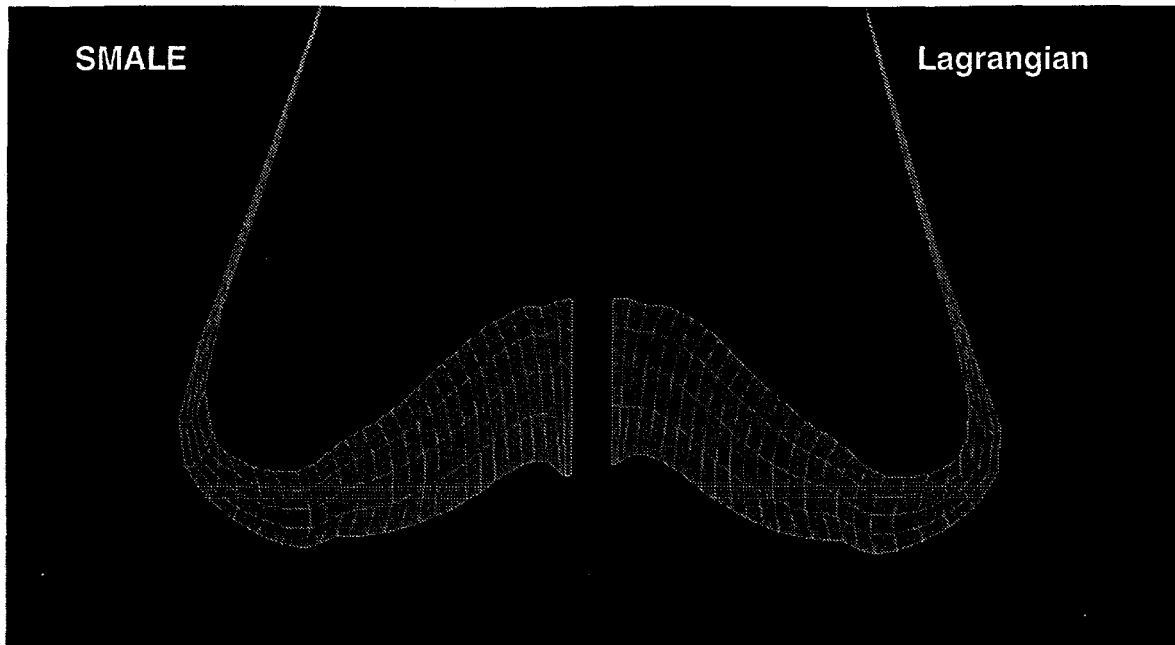
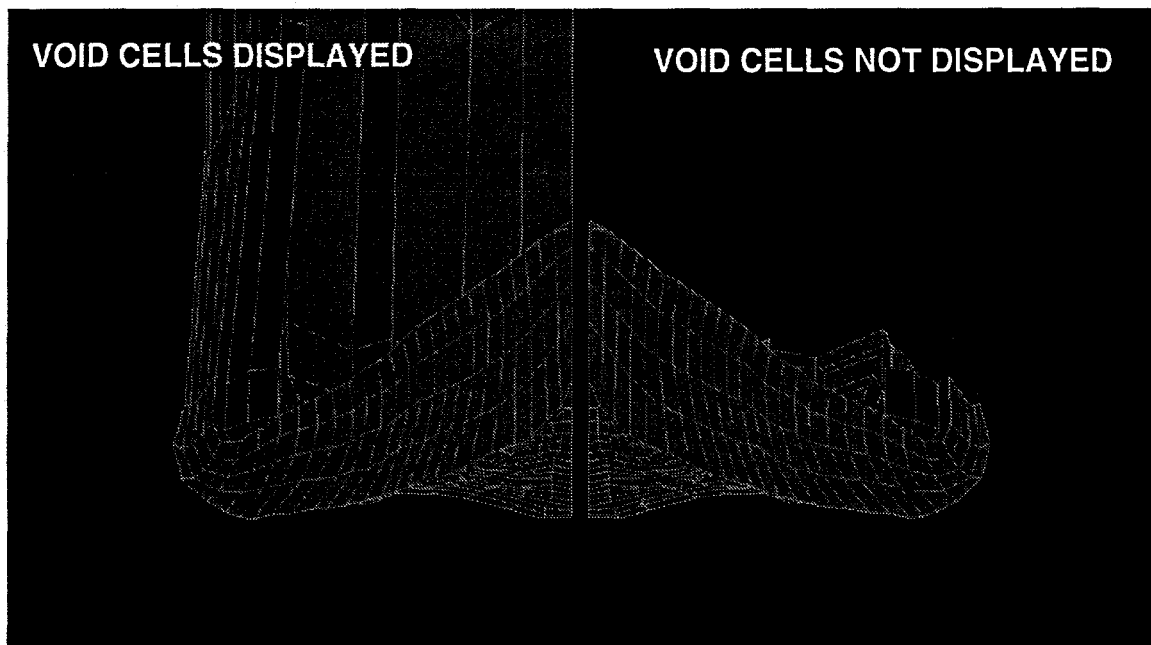
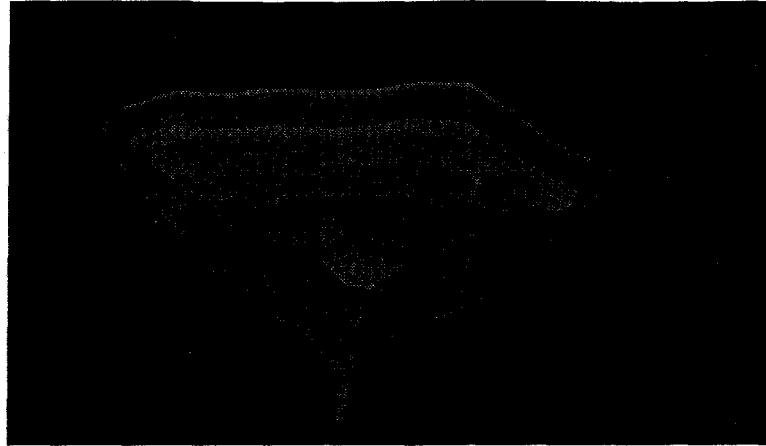

Figure 10: ALEGRA 3D Simulation with and without Void



CTH uses an Eulerian mesh to solve the conservation equations. Six geometry options are available in CTH: one-dimensional rectangular, cylindrical, and spherical; two-dimensional rectangular, and cylindrical; and three-dimensional rectangular. Up to twenty materials and void can occupy a computational cell, although the maximum number of materials can be changed by mod-

Figure 11: ALERGA 3D Simulation in Perspective View



ifying a single Fortran parameter statement. In general, all internal dimensions are controlled by Fortran parameter statements and can be easily modified by rebuilding the appropriate program or programs.

The conservation equations of mass, energy, and momentum are replaced by finite volume approximations. For those cases where exact conservation of mass, momentum, and energy is not possible, the user is allowed to control the internal accounting of these differences.

The mesh is generated from three sets of user specified spatial coordinates $x(i)$, $y(j)$, and $z(k)$ which are logically connected. All quantities are cell centered except the velocities which are face centered as described in Figure 12. During the Lagrangian step, all cell-centered quantities are as-

Figure 12: CTH Variable Locations

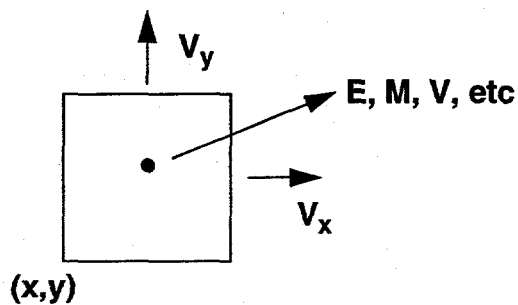

sumed to be constant across the cell. CTH uses a staggered mesh for the solution of the momentum conservation equation. However, this technique has been recently modified by including a method developed by Benson (1991) that advects face-centered quantities with a cell-centered algorithm. It has been found that the cell-centered solution technique for the momentum equation has simplified the numerical algorithms and allowed us to move the algorithms to parallel computers.

Solution Scheme

Eulerian codes like CTH use a mesh that is fixed in space, and material flows through the mesh in response to boundary and initial conditions. The conservation equations are solved in two steps, a Lagrangian step and a remap step. In the Lagrangian step, the Lagrangian forms of the governing equations are integrated across a timestep. The initial mesh distorts to follow the material motions and there is no mass flux across the cell boundaries. After the Lagrangian step, the remap step is performed. During the remap step, the distorted cells are remapped back to the initial fixed mesh. CTH also allows for a third step called the data base modification step. This step gives the user an opportunity to modify the data base in a few select cases.

The mass, momentum, and energy must be conserved across the Lagrangian step. The mass is conserved trivially because the mesh moves with the material during the Lagrangian step and no mass crosses the cell boundaries. The remaining conservation equations are replaced with explicit finite volume representations of the original integral equations. Although the explicit equations are solvable, the time step must be controlled to prevent information from crossing more than one cell during a single timestep. The timestep is the minimum of a CFL condition derived by Hicks (1977) and a cell-volume change limiting step. The volume change limit prevents excessive compression or expansion of a cell.

An area of considerable interest is the modeling of material strength. As Eulerian shock physics codes are increasingly used for modeling relatively low speed impacts, the emphasis has switched from equation-of-state issues to details of material response. A linearly-elastic perfectly-plastic material strength model is available in CTH. This model has two yield surface options: a von Mises (constant) yield surface and a pressure dependent yield surface. Both surfaces limit the second invariant of the stress deviator. The pressure dependent surface has low strength at low pressure and increasing strength as the pressure increases. Both models have thermal softening and low density degradation corrections available to the user.

In addition to the simple elastic plastic model, rate-dependent viscoplastic models are available in CTH: Johnson and Cook (1985), Zerilli and Armstrong (1987), and Steinberg et al. (1980). All of these models utilize complex functional forms of the yield surface which depends on both the local material state and some information about the history or rate-dependent state of the material. Complete descriptions of the functional forms are available in the noted references. The model of Johnson et al. (1990) describing the phenomena of brittle material failure is also available in CTH. This model replaces the normal CTH equation-of-state options with an internal description of the thermal response of the material.

Strength in compression is only one aspect of material response that is important for many of the current applications of CTH. Material fracture can also be critical in making accurate predictions. CTH has historically used a void insertion model to simulate failure. This model monitors the tensile state of a cell and after exceeding a criteria (P_{min}), relieves that tension by adding void. The model allows the user to select either pressure or principal stress as the criteria for tension relief. This technique is adequate to predict material failure due to hydrodynamic spall, but does not predict failure due to shear phenomena or large strains. An equivalent plastic strain based model of Johnson and Cook (1989) has been implemented in CTH. This model predicts failure due to shear deformation. The model is coupled with the void insertion model through the user specified cut-off tensile pressure or stress. If the user requests the Johnson-Cook fracture model, the user specified value for the maximum tension that can be supported is degraded by the fraction of

failed material. As the failure due to shear deformation increases, the amount of tension that a cell can support decreases until the cell can support no tension. At this point the material has completely failed and will act like a fluid. Limited testing with this model indicates that it is stable and predicts reasonable results, but further testing is required.

A three term artificial viscosity is used to control the discontinuity associated with shocks and other instabilities. The form used to control shocks is a vector subset of the full viscosity tensor with linear and quadratic terms. The vector includes the diagonal elements xx , yy , and zz . Artificial viscosity in this form is the preferred shock capturing method for hydrocodes. Shock tracking techniques are not commonly used because no prior knowledge exists of the wave structures, a necessary piece of information to accomplish shock tracking. The third viscosity term is linear and controls a singular point in the update of the stress deviators at the axis-of-symmetry for the two-dimensional cylindrical geometry option. Shear viscosity has been found to control non-physical oscillations sometimes seen in normal penetration simulations.

There are currently four high explosive detonation and/or initiation models in the production version of CTH. The oldest is the programmed burn model, which is appropriate for simple detonations where the initiation time and location can be prescribed. This model automatically calculates the appropriate amount of energy to be deposited in each cell of high explosive at the correct time. The three additional models are capable of modeling the shock initiation, as well as the detonation of high explosives. They are the Chapman-Jouguet, History Variable Reactive Burn models (Kerley 1992), and the multi-phase reactive flow model (Baer and Nunziato 1986,1989). These models rely on the use of internal state variables to monitor the reaction parameters of the high explosive initiation.

All of the models discussed above are applied during the Lagrangian step. After this step, the velocities, energies, stress deviators, and any internal state variables must be remapped back to the initial mesh. It is during the remap step where much of the cpu time is consumed and where numerical intricacies are important.

The remap step advects the appropriate mass, momentum, energy, and volume from the deformed mesh of the Lagrangian step to the original mesh. The volume flux between the old and new cells is calculated first. An interface tracking algorithm then decides which materials in the old cells are moved with the volume flux. Next, each material's mass and internal energy are moved from the old to the new cells. Finally, the momentum and kinetic energy are moved using the information from the interface tracker.

Operator splitting techniques are used to preform the multi-dimensional remap operation. The resulting one-dimensional convection equations use a second-order accurate conservative scheme developed by van Leer (1977). The scheme used in CTH replaces a uniform distribution in the old cell with a linear distribution. To reduce the asymmetry resulting from the operator splitting, a permutation scheme in direction is applied.

The volume flux is calculated from the geometry of the cell-face motion. Once that is calculated, the volume of materials to be advected must be estimated. The interface reconstruction algorithms are used to estimate the amount of each material to be advected. Three interface reconstruction algorithms are available in CTH. The Simple Line Interface Calculation scheme developed by Noh and Woodward (1976) is available for all geometries. This technique is exact for one-dimensional geometries and effectively first-order for other geometries. A higher resolution (second order) interface reconstruction scheme developed by McGlaun et al. (1990) is also available for two-di-

mensional geometries. The Sandia Modified Youngs' Reconstruction Algorithm (Bell and Hertel, 1992) is available for two- and three-dimensional simulations. This second order accurate algorithm gives virtually identical results to the McGlaun scheme in two-dimensions. It is based on the work by Youngs (1987) and has been implemented in Sandia's ALEGRA code.

In most formulations of the momentum advection equation, a staggered mesh is constructed in space and time. The staggered mesh is only used to advance the face-centered (velocity) variables for use by the next Lagrangian step. The staggered mesh requires additional storage and a second and different formulation of the difference equations for momentum advection. A technique developed by Benson (1991) has been recently implemented in CTH as a part of other upgrades. This technique maps the portions of the face-centered information to cell-centered locations and then performs the advection on the cell-centered data. The method requires advection of twice as much information but reduces the complexity of the advection scheme significantly. The first step is to map the respective halves of the momentum to the adjacent cell-centers. The step leaves two pieces of data at the cell-centers for advection. The second step advects the new cell-centered data using the normal advection algorithm for cell-centered data. After the advection step is complete, the separate halves of the cell-centered momentum are mapped back to the face locations and a face-centered velocity is calculated. This technique has been found to be very effective and guarantees that the accuracy of the advection scheme is maintained and has the additional benefit of also being a monotone scheme.

The three basic variables of mass, momentum, and kinetic energy are calculated from two data base quantities: mass and velocity. As a result, the three basic variables cannot all be conserved across the remap step. Older versions of CTH allowed the user to select how this discrepancy is resolved.

Strong shock simulations require sophisticated and accurate models of the thermodynamic behavior of materials. Phase changes, nonlinear behavior, and fracture can be important for accurate predictions. CTH has two major equation-of-state packages available to the user: the Analytic Equation-of-State (ANEOS) package of Thompson and Lauson (1972) and the SNL-SESAME package of Kerley (1991).

The ANEOS package uses a Helmholtz potential to calculate the internal energy as a function of mass density and temperature. The use of a Helmholtz potential assures thermodynamic consistency. The ANEOS package allows for three-phase (solid-solid, liquid-vapor, liquid-solid, and solid-vapor) equations-of-state. In addition to the multi-phase analytic forms, there are three simple analytic expressions within the ANEOS package. Expressions for a linear $U_s - u_p$ (Mie-Gruneisen), Jones-Wilkins-Lee (explosives), and ideal gas equations-of-state are subsets of the multi-phase analytic forms. The drawbacks of the ANEOS package are that it can be difficult for the novice to parameterize and is computationally inefficient.

The SNL-SESAME package is based on the SESAME tabular equation-of-state representation. The tabular form allows the equation-of-state to be as sophisticated as the information contained in the table. The tabular representations may contain multiple liquid-vapor, liquid-solid, and solid-solid transitions whereas, ANEOS is restricted to at most three. Table look-up schemes can be made very efficient on vector and parallel computers. Once the tables have been constructed, they are accessible to all users. In addition to the tabular representations, analytic forms for linear $U_s - u_p$ (Mie-Gruneisen), Jones-Wilkins-Lee, and ideal gas equations-of-state are also available. The SNL-SESAME package contains two models that can be used to represent porous media. A

“two-state” model can be used to model reversible compaction and the $p-\alpha$ model can be used for irreversible compaction.

Conclusions

The real revolution in shock physics modeling using hydrocodes comes not from algorithm development but from advances in computing hardware. Figure 13 demonstrates the recent progression in computing hardware. This figure depicts the change in run time for a nominal CTH simulation

Figure 13: Progress in Computing

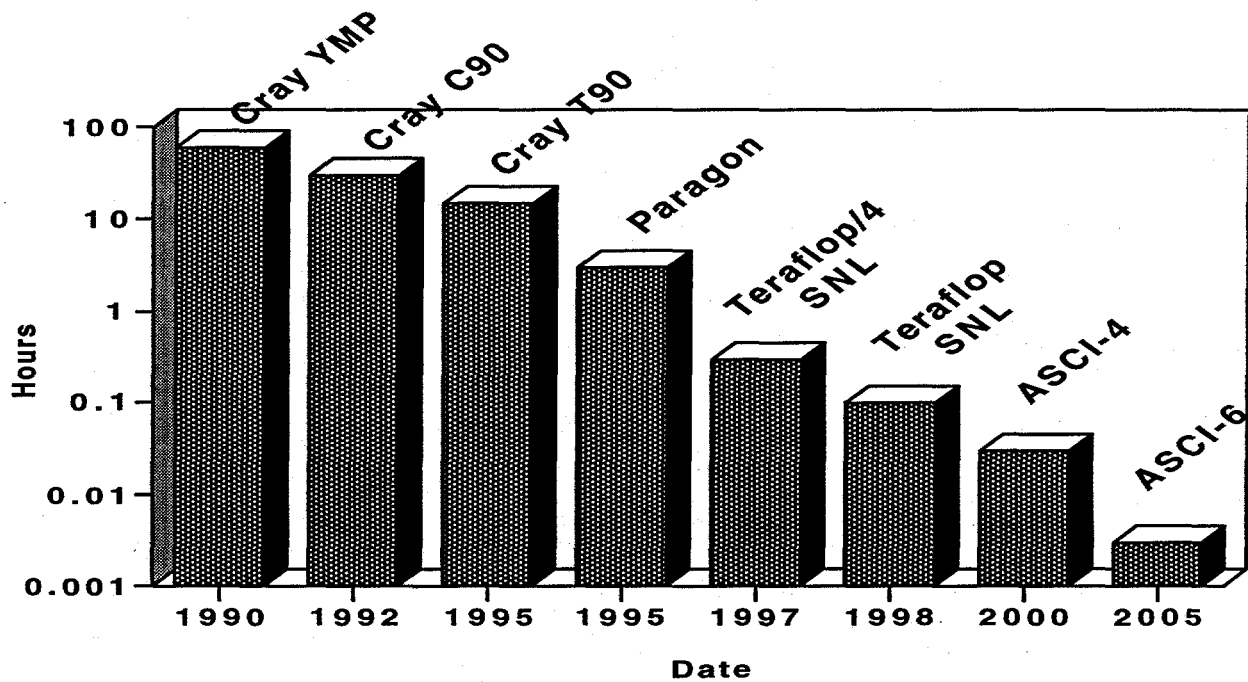

(1,000,000 computational cells run for 7500 timestep with 6 materials) as a function of computers/time. Assuming no change in the schedule for hardware upgrades, the run time for the nominal simulation has dropped by almost 5 orders of magnitude! This increase is in addition to another 5 orders of magnitude in performance since the dawn of electronic computers.

In summary, Eulerian techniques are widely used in shock physics analysis due to their ability to handle large deformation robustly, but Lagrangian techniques can offer significant advantages in computational efficiencies due to reduced meshing requirements. Arbitrary Lagrangian Eulerian techniques may be able to bridge the gap between the individual methods to solve a new class of problems, but are still in development. Mesh-less techniques are new and also in the development stage but may offer the best features of both Eulerian and Lagrangian codes. In the process of

finding an answer, the quality of the analyst may be more important than the quality of the solution technique.

References

- Baer, MR and Nunziato, JW, "A Two-Phase Mixture Theory for Deflagration-to-Detonation Transition (DDT) in Reactive Granular Materials," *International Journal of Multiphase Flow*, Vol. 12, 1986
- Baer, MR and Nunziato, JW, "Compressive Combustion of Granular Materials Induced by Low-Velocity Impact," Ninth Symposium (International) on Detonation, ONR 113291-7, 1989
- Bell, RL and Hertel, ES, "An Improved Material Interface Reconstruction Algorithm Eulerian Codes," 92-1716, 1992
- Belytschko, T, "Computer Methods in Shock and Wave Propagation Analysis," *Computing in Applied Mechanics*, ASME AMD, vol. 18, 1976
- Benson, DJ, "Momentum Advection on a Staggered Mesh," *J. Comp. Phys.* 100:1, 1991
- Benson, DJ, "Computational Methods in Lagrangian and Eulerian Hydrocodes," *Computer Methods in Applied Mechanics and Engineering*, 99, 1992
- Boris, JP, Landsberg, AM, Oran, ES, and Gardner, JH, "LCPFCT- A Flux-Corrected Transport Algorithm for Solving Generalized Continuity Equations," Naval Research Laboratory, NRL/MR/6410-93-7192, 1993
- Brannon, RM and Wong, MK, "Model Interface Guidelines," Sandia National Laboratories, work in progress, 1996
- Bammann, DJ, Chiesa, ML, McDonald, A, Kawahara, WA, Dike, JJ, and Revelli, VD, "Prediction of Ductile Failure in Metal Structures," in *Failure Criteria and Analysis in Dynamic Response*, Ed. HE Lindberg, ASME AMD, vol. 107, 1, 1990
- Evans, ME and Harlow, FH, 'The Particle-in-Cell Method for Hydrodynamic Calculations,' Los Alamos Scientific Laboratory, LA-2139, 1957
- Embid, P and Baer, MR "Mathematical Analysis of a Two-Phase Continuum Mixture Theory", *Continuum Mechanics and Thermodynamics*, Vol 4, 1992
- Fahrenthold, EP and Koo, JC, 'Hamiltonian Particle Hydrodynamics,' *Computer Methods in Applied Mechanics and Engineering*, in press, 1992
- Gross, R.J and Baer, MR, "A Study of Numerical Solution Methods for Two-Phase Flow," Sandia National Laboratories, SAND84-1633, 1986
- Hermann, W, Holzhauser, P, and Thompson, RJ, "WONDY, A Computer Program for Calculating Problems of Motion in One Dimension," Sandia Laboratories, SC-RR-66-601, February 1967
- Hicks, DL, "von Neumann Stability of the WONDY Wavecode for Thermodynamic Equations of State." Sandia Laboratories, SAND77-0934, 1977
- Johnson, GR, and Cook, JH, "Fracture Characteristics of Three Metals Subjected to Various Strains, Strain Rates, Temperatures, and Pressures," *Engrg. Frac. Mech.* 21:31, 1985
- Johnson, GR and Holmquist, TJ, "Test Data and Computational Strength and Fracture Model Constants for 23 Materials Subjected to Large Strains, High Strain Rates, and High Tempera-

tures," Los Alamos National Laboratory, LA-11463-MS, 1989

Johnson, GR, Holmquist, TJ, Lankford, J, Anderson, CE, and Walker, J, "A Computational Constitutive Model and Test Data for Ceramics Subjected to Large Strains, High Strain Rates, and High Pressures," Honeywell report, DE-AC04-87AL-42550, 1990

Johnson, GR, Stryk, RA, Peterson, EH, Holmquist, TJ, Schonhardt, JA, and Burns, CA, "User Instructions for the 1995 Version of the EPIC Code," Honeywell report, 1994

Kerley, GI, "CTH Reference Manual: The Equation-of-State Package," Sandia National Laboratories, SAND91-0344, 1991

Kerley, GI, "CTH Equation of State Manual: Porosity and Reactive Burn Models," Sandia National Laboratories, SAND92-0553, 1992

Landsberg, AM, Boris, JP, Young, TR, and Scott, RJ, "Recomputing Complex Shocked Flows Through the Euler Equations," Proceeding of the 19th International Symposium on Shock Waves, University of Provence, Marseille, France, 1993

McGlaun, JM, Thompson, SL, Kmetyk, LN, and Elrick, MG, "CTH: A Three-Dimensional Shock Wave Physics Code," Int. J. Impact Engng. 10:351, 1990

Noh, WF and Woodward, P, "SLIC (Simple Line Interface Calculation)," Proceedings of the Fifth International Conference on Numerical Methods in Fluid Dynamics, Springer Lecture Notes in Physics 59:330, 1976

Oran, ES and Boris, JP, "Numerical Simulation of Reactive Flow," Elsevier, pp 134-180, 1987

Steinberg, DJ, Cochran, SG, and Guinan, MW, "A Constitutive Model for Metals Applicable at High Strain Rate," J. Appl. Phys. 51:1498, 1980

Richtmyer, RD and Morton, KW, "Difference Methods for Initial Value Problems," 2nd Edition, Interscience Publishers, New York, 1976

Taylor, PA, "CTH Reference Manual: The Transverse Isotropic (TI) Model," Sandia Laboratories, 95-2750, December 1995

van Leer, B "Towards the Ultimate Conservative Difference Scheme IV. A New Approach to Numerical Convection," J. Comp. Phys. 23:276, 1977

Youngs, DL, "An Interface Tracking Method for a 3D Eulerian Hydrodynamics Code," Atomic Weapons Research Establishment, AWRE/44/92/35, 1987

Zerilli, FJ and Armstrong, RW, "Dislocation-Mechanics-Based Constitutive Relations for Material Dynamics Calculations," J. Appl. Phys. 61:1816, 1987